

STYLE GUIDE



Narellanpools^o

narellanpools.com.au
1300 676 657

CELEBRATING OVER 50 YEARS OF BRINGING DREAMS TO LIFE

With over 50 years of experience, Narellan Pools has grown to become an iconic brand.

Our commitment to manufacturing quality fibreglass swimming pools and delivering the best and most loved client experiences sets us apart.

Through our qualified, skilled and passionate local Pool Builders, we continue to help our clients achieve the lifestyle of their dreams and create lifelong memories.

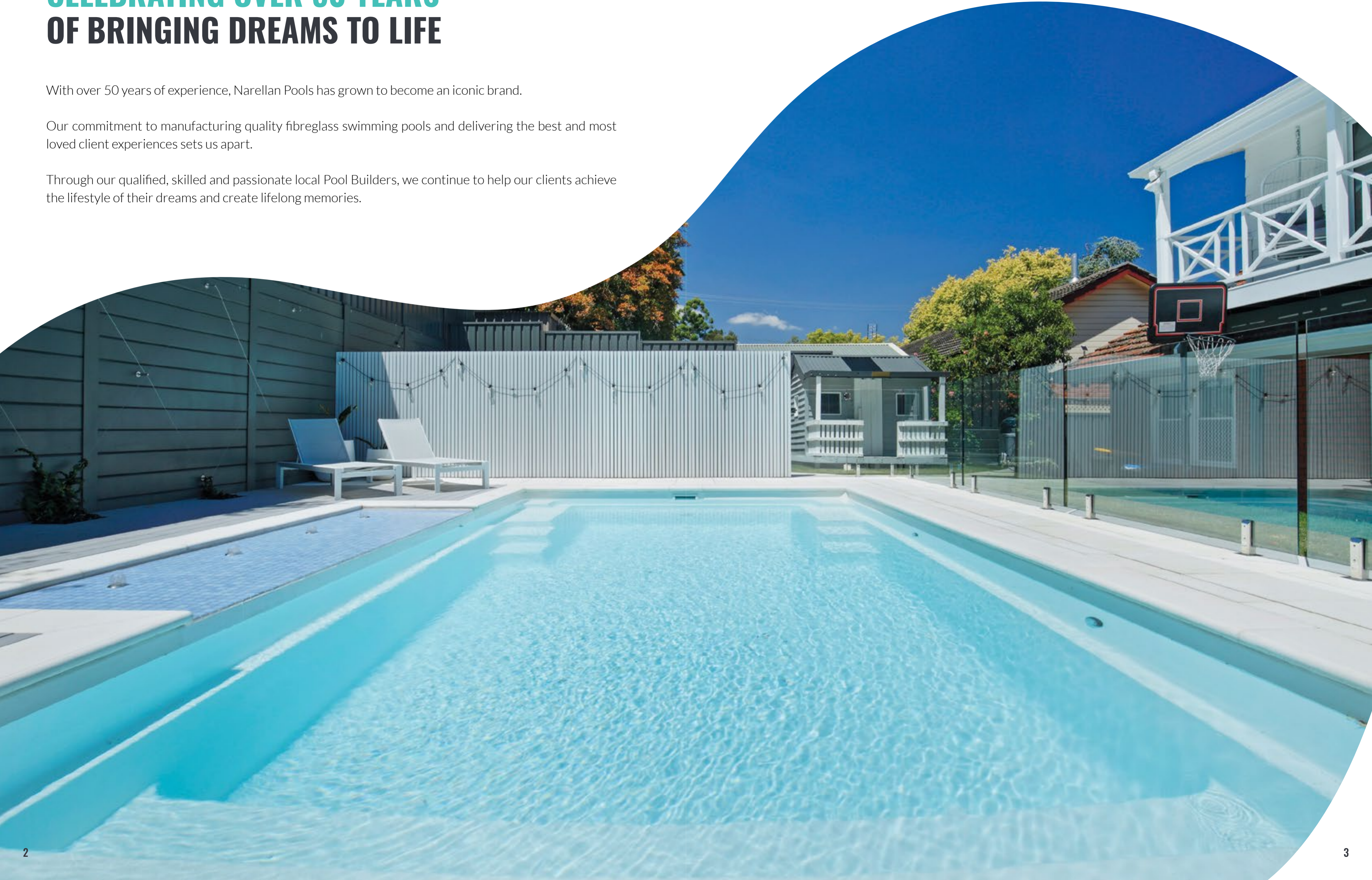

TABLE OF CONTENTS

ABOUT US	6	YOUR CHOICES	18
ALL POOLS ARE NOT EQUAL	10	- ASTORIA	20
THE ONLY CHOICE	11	- SYMPHONY	22
OUR DESIGNS	14	- SERENE	24
COLOUR RANGE	16	- GRANDEUR	26
		- PANAMA	28
		- FEDERATION	30
		- ATLANTIS	32
		- ROCKPOOL	34
		- PRINCESS	36
		- EDEN	38
		- NIRVANA	40
		- PLUNGE POOLS	42
		- SPAS AND SPLASH DECK	44
		NARELLAN POOLS INGROUND POOL COVER	46
		CUSTOMISE YOUR POOL	47
		ABOVE GROUND POOLS	48
		OUR WARRANTY,	54
		OUR MANUFACTURING	56
		ENVIRONMENTALLY CONSCIOUS	59
		AUGMENTED REALITY (AR) APP	60
		LOCAL POOL BUILDER	62
		INSTALLATION	64
		OUR PHILANTHROPY	66
		THE SPLASH FOUNDATION BY NARELLAN POOLS	66



Above Ground Symphony 7, Whitehaven Pearl

ABOUT US

With over 50 years of experience, Narellan Pools are Australia's most respected and most trusted pool builders.

Over 50 years of making more than just pools; Narellan Pools have been bringing backyards to life, creating memories, and helping friends and families live the quintessential 'Great Australian Dream'.

50+ years on, the Narellan Pools network consists of scores of local Pool Builders, operating across Australia, New Zealand, Canada and the United States of America.

ABOUT YOU

We are dedicated to delivering the best personalised service and tailored solutions for you. We ensure that your experience purchasing a pool from Narellan Pools is straight-forward and clear, and we're passionate about making your dream pool a reality.

Our team understands purchasing a pool is a significant decision and investment, and because of this we promise to work with you every step of the way. Integrity and transparency are critical to how we operate and underpin every client interaction. We take time to understand your dream pool and we're passionate about bringing it to life.

Our goal and focus is for you to feel listened to, respected and looked after every step of the way.

OUR PROMISE

- Peace of mind knowing we have been in business for 50 years
- High-quality pools, with beautiful contemporary designs
- Design and style consultation to ensure your pool harmonises with your home
- Practical and innovative solutions
- Professional advice and tailored service
- A transparent process from start to finish





ALL POOLS ARE NOT EQUAL

With over 50 years of innovation, engineered science and technology has resulted in the creation of our outstanding fibreglass pool shell.

Our proprietary gelcoat and laminate construction ensures our inground pools withstand all sorts of climate conditions and soil types.

This quality is backed by world-class quality control measures and our Inground Lifetime Structural Warranty.

When you choose Narellan Pools, you are choosing quality and expertise.



Hand Crafted



Durable and Resilient



Aerospace Technology



Meticulously Inspected



Ultrasonic Tested



Installed With Love

THE ONLY CHOICE

Installing a pool is one of the most important decisions you can make as a homeowner. You're not only updating your backyard with a new feature, you're creating an oasis where you will share in treasured moments with family and friends.

Therefore, it's important to choose the right pool builder - one that will look after you every step of the way. You can rely on your local Narellan Pools Builder to support you through the journey to pool ownership.

OUR DESIGNS

— Premium Fibreglass Pools —

Grandeur 11, Whitehaven Pearl

OUR DESIGNS



Serene 7, Whitehaven Pearl

Swimming Pools

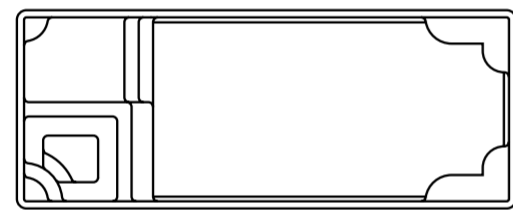

NEW Astoria 10.7 P.20

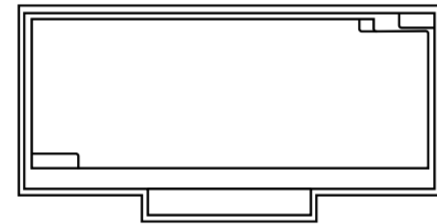

Symphony 5-12 P.22

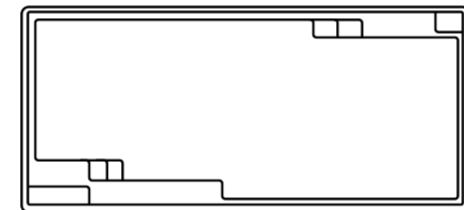

Serene Slimline 6, Serene 6-9 P.24

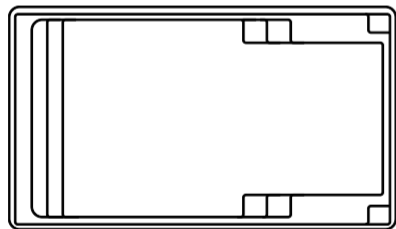

Grandeur 7, 9, 11 P.26



Panama 5, 8, 11 P.28



Federation 8, 9, 11 P.30

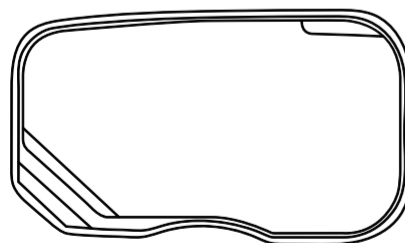

Atlantis 6-10, 12 P.32

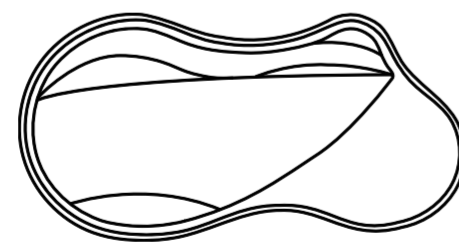

Rockpool 7 P.34

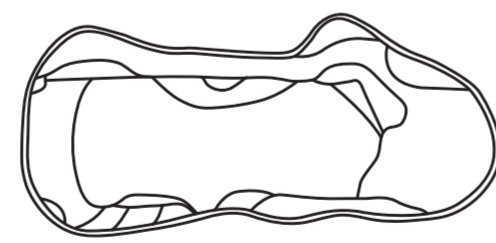

Rockpool 9 P.36

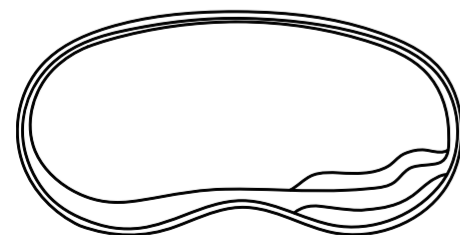

Princess 7-10 P.38

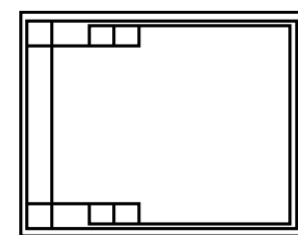

Eden 3.5, 4.5, 5.5, Slimline 5 P.40

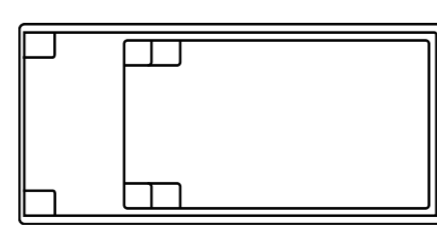

Nirvana 5-7 P.42

Plunge Pools | Spas & Splash Deck

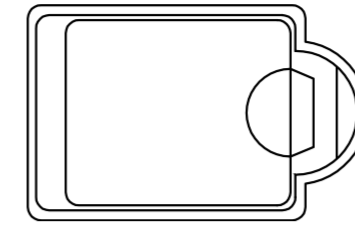

Pinto & Pinto Plus Plunge Pool

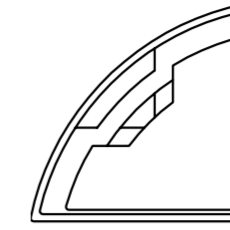

Oasis Plunge Pool

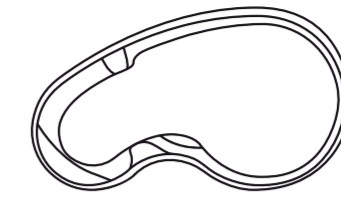

Princess Spa 6 P.38

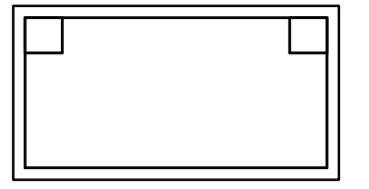

Harmony Splash Deck

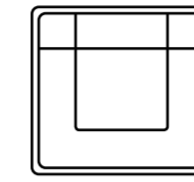

Neptune Spa

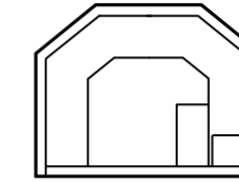

Party Spa



Symphony 10, Mediterranean Pearl



Eden 4.5, Blue Agate

COLOUR RANGE

With our most durable finish to date, our ever-expanding colour range sees the introduction of the Pearl Essence to our Range. We are committed to developing finishes and colours that display a greater depth of colour and luminescence for longer.

Blues



Blue Agate, Symphony 8

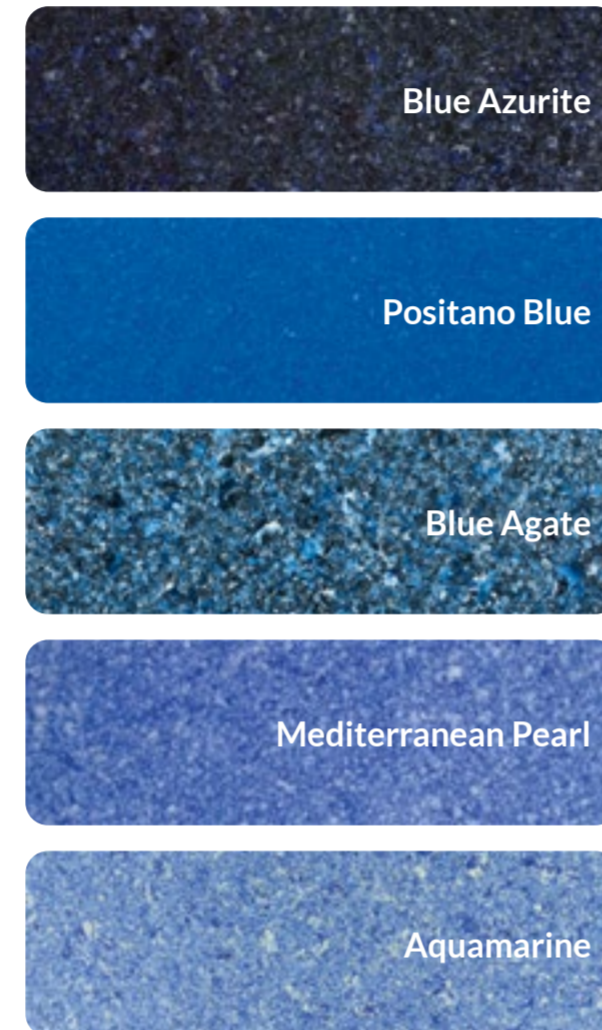

Monochromatic



Platinum Pearl, Serene 8

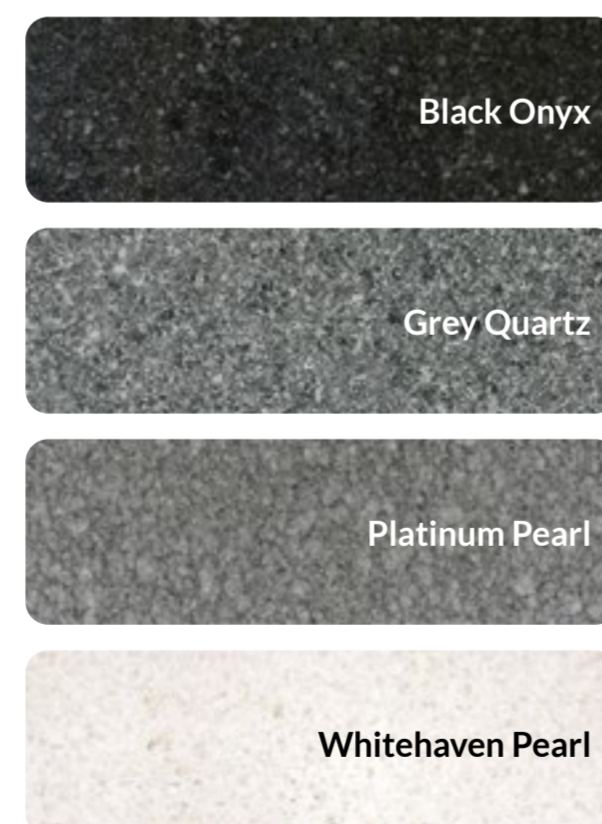

We use the latest gelcoat technology which is the ultimate in modern design. With better chemical resistance, and more flexibility, your Narellan pool will look beautiful for many years to come.

With over 50 years of innovation and passion for research and development, this has allowed us to develop the unique technology which blends solid colours beautifully, resulting in a vibrant range of colours that are more colour fast and less susceptible to UV degradation.

Sands/Stones



Summer Stone, Oasis



Greens

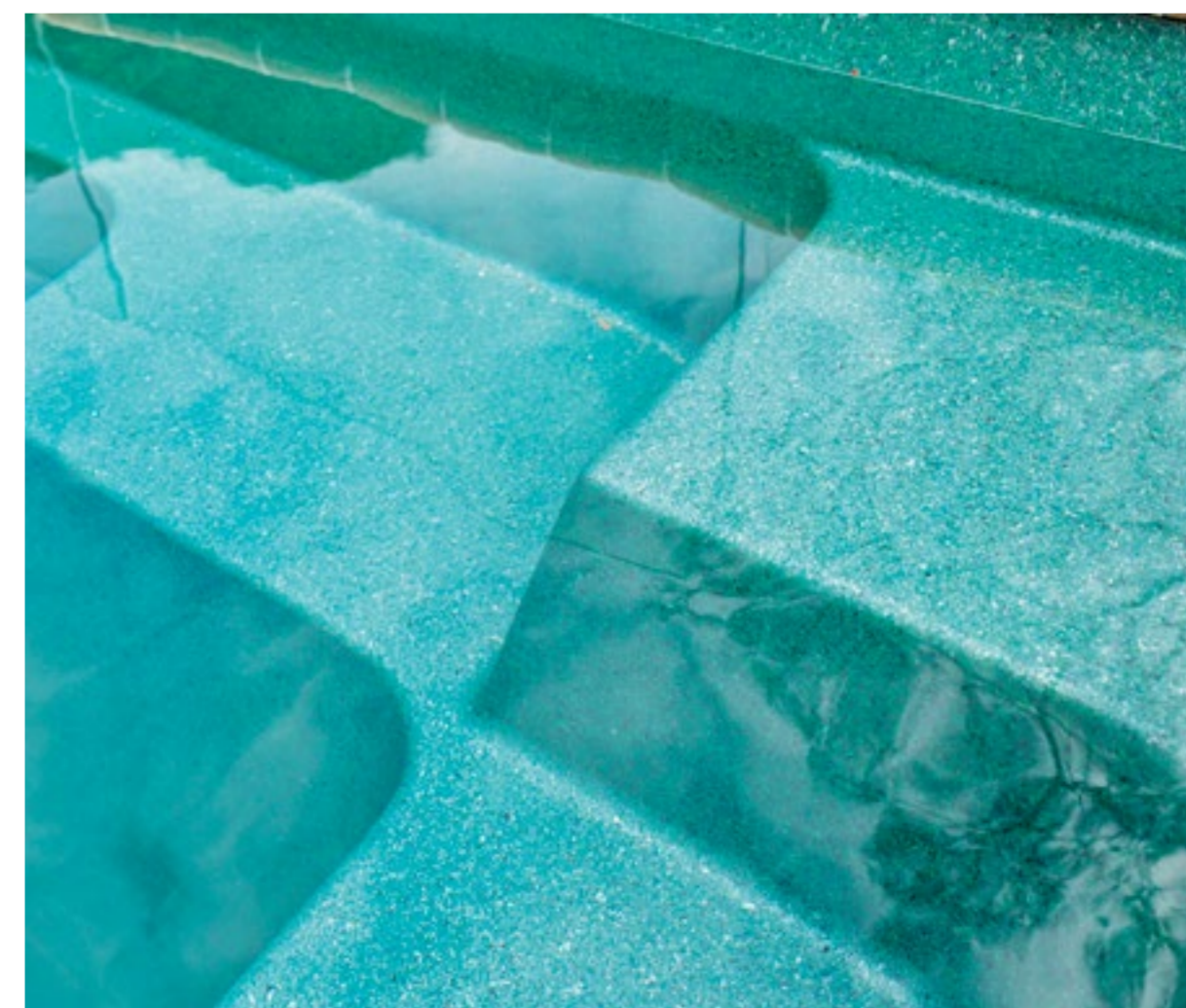

Green Malachite, Eden 5



YOUR CHOICES

— Premium Fibreglass Pools —



NEW

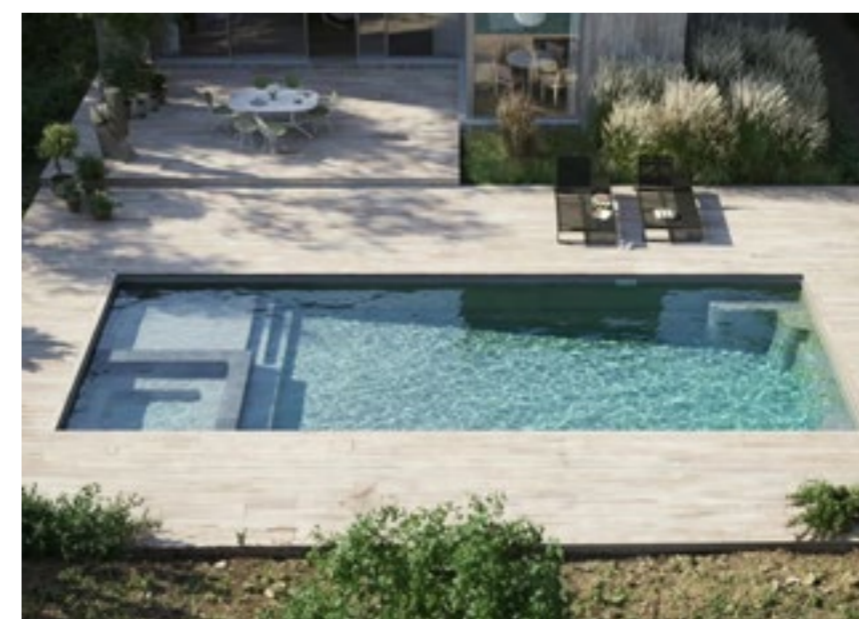

ASTORIA

The epitome of luxury, the Astoria is a sleek, rectangular pool with a built-in spa and splash deck, offering the best of both worlds with an all in one design. Beautiful and versatile, the Astoria is packed with features that the whole family will enjoy.

Features

- Built-in spa with bench seating around the perimeter of the spa, seating 6 adults
- Splash deck for lounging or wading for the kids
- Swim-up benches to seat all your guests
- Gradual depth and safety ledge for learning to swim
- All in one fibreglass pool shell designed for durability, strength and resilience
- Available as a mineral water pool or salt water pool

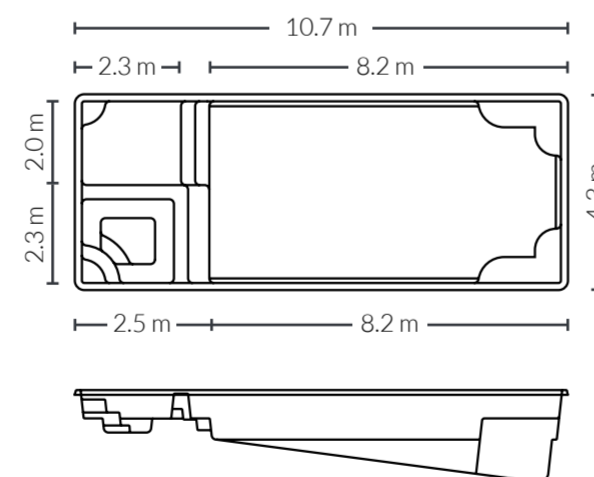

Waterline Dimensions

Name	Length	Width
Astoria 10.7	10.3 m	3.9 m

External Dimensions

Length	Width	Depth
10.7 m	4.3 m	1.07m - 1.98m

*Lengths, widths and depths may vary up to 3%. Dimensions are the length and width measured at the top of the coping. Depth is from deepest part of internal shell coping. Some measurements are rounded. Unless indicated otherwise, pools are non-diving and use of diving equipment is prohibited.



Grey Quartz

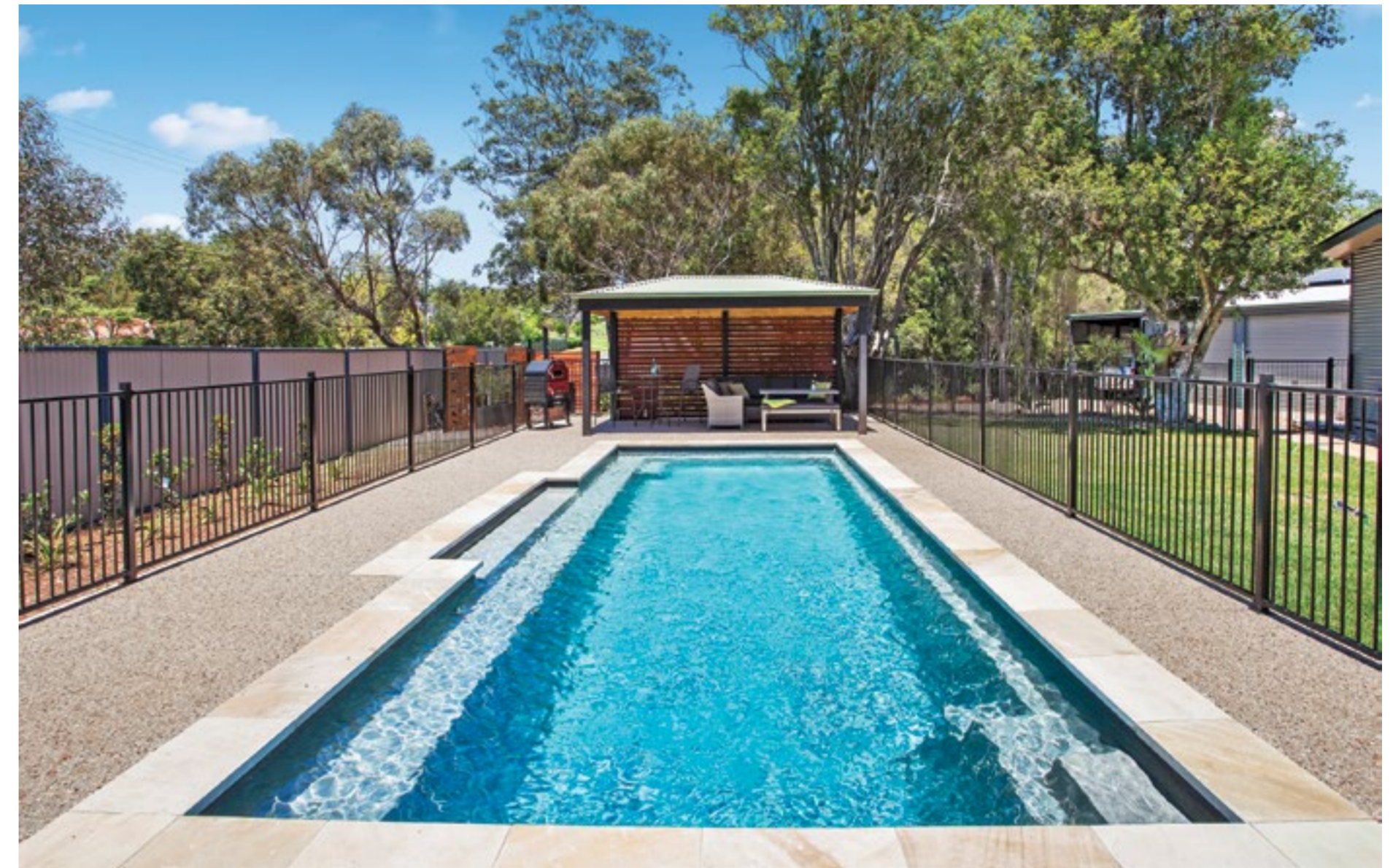

River Rock

SYMPHONY

The pinnacle of design with its contemporary clean lines and functional appeal. Featuring a long bench seat and deep end steps, the Symphony is the ideal extension to your family home.

Features

- Wide steps and seating ledge along the length of the pool
- Gradual depth for wading and learning to swim
- Child safety ledge around the perimeter
- Durability, strength and resilience-tested fibreglass pool shell
- Available as a Mineral Water Pool or Salt Water Pool
- Above Ground options available on Symphony 9 and below

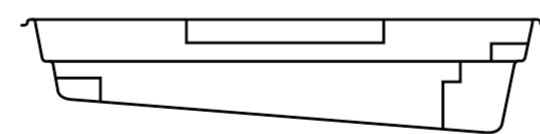
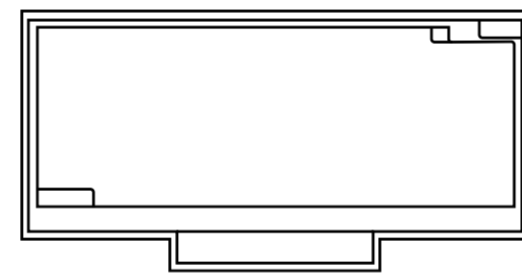

Whitehaven Pearl

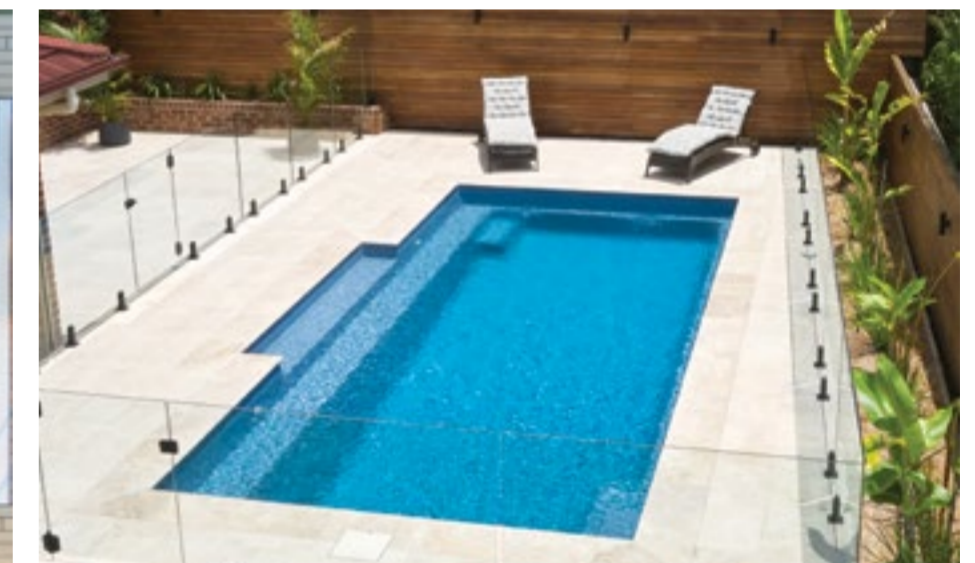

Blue Agate

Waterline Dimensions

Name	Length	Width
Symphony 5	5.0 m	3.1 m
Symphony 6	6.0 m	3.1 m
Symphony 7	7.0 m	3.6 m
Symphony 8	8.0 m	3.9 m
Symphony 9	9.0 m	3.9 m
Symphony 10	10.0 m	3.9 m
Symphony 11	11.0 m	3.9 m
Symphony 12	11.7 m	3.9 m

External Dimensions

Length	Width	Depth
5.3 m	3.5 m	1.20 m - 1.51 m
6.3 m	3.5 m	1.20 m - 1.58 m
7.3 m	3.9 m	1.20 m - 1.65 m
8.3 m	4.2 m	1.20 m - 1.73 m
9.3 m	4.2 m	1.20 m - 1.80 m
10.3 m	4.2 m	1.20 m - 1.86 m
11.3 m	4.2 m	1.20 m - 1.95 m
12.0 m	4.2 m	1.20 m - 1.99 m

*Lengths, widths and depths may vary up to 3%. External measurements are to widest point on each side of the outside edge. Waterline dimensions are the length and width measured at the top of the coping. Depth is from deepest part of internal shell coping. Unless indicated otherwise, pools are non-diving and use of diving equipment is prohibited.



Blue Azurite



Grey Quartz



Serene Slimline 6, Positano Blue



Mediterranean Pearl



Aquamarine



Blue Azurite

SERENE

The Narellan Pools Serene Pool is the perfect balance of functionality and style. Featuring an unobstructed swimming corridor and long bench seat, this pool is the ideal choice for entertaining and fun.

Features

- Long bench seat to sit and relax
- Child safety ledge around the perimeter
- Gradual depth for wading and learning to swim
- Durability, strength and resilience-tested fibreglass pool shell
- Available as a Mineral Water Pool or Salt Water Pool
- Above Ground option available on full Serene range

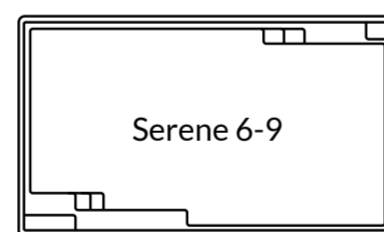
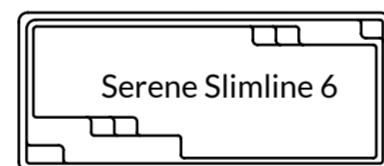

Waterline Dimensions

Name	Length	Width
Serene Slimline 6	6.0 m	2.6 m
Serene 6	6.0 m	3.5 m
Serene 7	7.0 m	3.5 m
Serene 8	8.0 m	3.5 m
Serene 9	9.0 m	3.5 m

External Dimensions

Length	Width	Depth
6.3 m	2.9 m	1.20 m - 1.55 m
6.3 m	3.8 m	1.20 m - 1.55 m
7.3 m	3.8 m	1.20 m - 1.65 m
8.3 m	3.8 m	1.20 m - 1.75 m
9.3 m	3.8 m	1.20 m - 1.80 m

*Lengths, widths and depths may vary up to 3%. External measurements are to widest point on each side of the outside edge. Waterline dimensions are the length and width measured at the top of the coping. Depth is from deepest part of internal shell coping. Unless indicated otherwise, pools are non-diving and use of diving equipment is prohibited.



Black Onyx

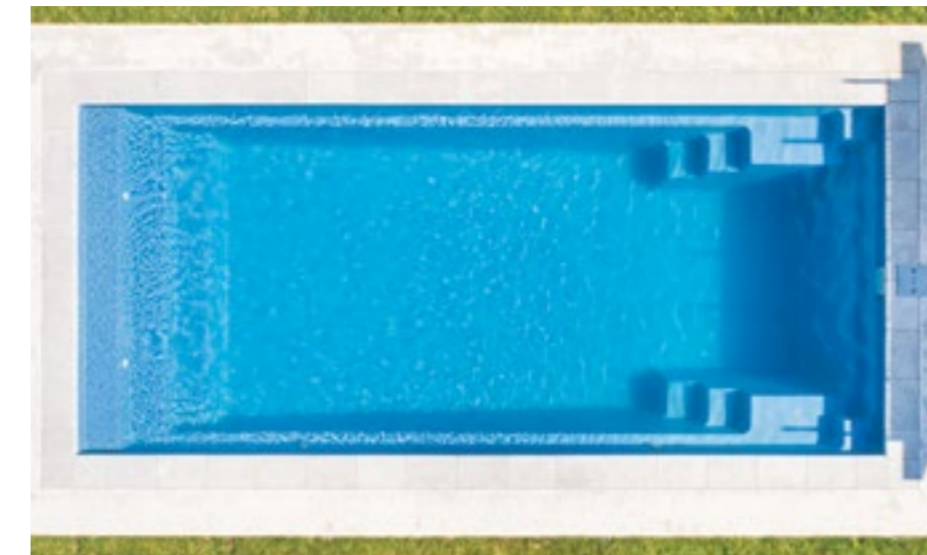

Blue Agate



Positano Blue



Grey Quartz

GRANDEUR

Make a grand statement with the elegant staircase entry and dual deep end bench seats. The Grandeur is the perfect centrepiece for your summer days and nights.

Features

- Convenient wide steps across the width of the pool
- Steps at each end of the pool for ease of entry and exit
- Child safety ledge around the perimeter
- Gradual depth for wading and learning to swim
- Durability, strength and resilience-tested fibreglass pool shell
- Available as a Mineral Water Pool or Salt Water Pool
- Above Ground option available on Grandeur 9 and below

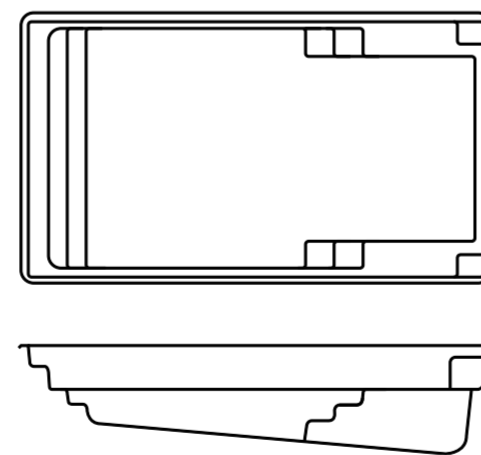

Waterline Dimensions

Name	Length	Width
Grandeur 7	7.0 m	4.0 m
Grandeur 9	9.0 m	4.0 m
Grandeur 11	11.0 m	4.0 m

External Dimensions

Length	Width	Depth
7.3 m	4.2 m	1.2 m - 1.65 m
9.3 m	4.2 m	1.2 m - 1.80 m
11.3 m	4.2 m	1.2 m - 1.95 m

*Lengths, widths and depths may vary up to 3%. External measurements are to widest point on each side of the outside edge. Waterline dimensions are the length and width measured at the top of the coping. Depth is from deepest part of internal shell coping. Unless indicated otherwise, pools are non-diving and use of diving equipment is prohibited.



Whitehaven Pearl



Aquamarine



Grey Quartz



River Rock



Blue Azurite

PANAMA

Keep fit in the comfort of your own backyard with our lap pool design. With a single depth throughout, the Narellan Pools Panama Lap Pool is perfect for swimming laps and getting your daily exercise as well as being great for family fun and games. The functional design including dual entry steps provides greater flexibility when placing the Panama Pool in your backyard.

Features

- Functional and practical design
- Double entry steps
- Streamlined design with single depth, perfect for swimming laps
- Clear swim channel for continuous tumble turn swimming
- Narrow width for smaller backyards
- Child safety ledge around the perimeter
- Durability, strength and resilience-tested fibreglass pool shell
- Available as a Mineral Water Pool or Salt Water Pool
- Above Ground option available on Panama 8 and below

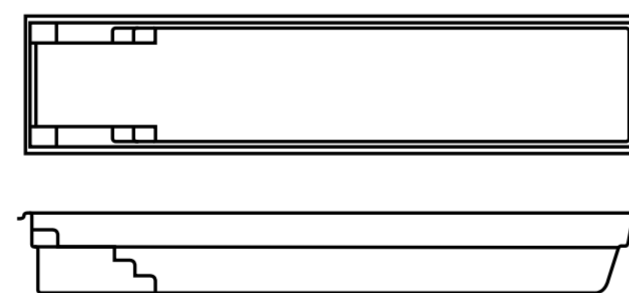

Waterline Dimensions

Name	Length	Width
Panama 5	5.0 m	2.3 m
Panama 8	8.0 m	2.3 m
Panama 11	11.0 m	2.3 m

External Dimensions

Length	Width	Depth
5.3 m	2.5 m	1.45 m
8.3 m	2.5 m	1.45 m
11.3 m	2.5 m	1.45 m

*Lengths, widths and depths may vary up to 3%. External measurements are to widest point on each side of the outside edge. Waterline dimensions are the length and width measured at the top of the coping. Depth is from deepest part of internal shell coping. Unless indicated otherwise, pools are non-diving and use of diving equipment is prohibited.



Mediterranean Pearl



Blue Azurite



Blue Agate



Black Onyx



Aquamarine

Mediterranean Peel

FEDERATION

The Federation is a beautiful, classic pool design. With its long lines and wide entry steps, this pool makes a stunning centrepiece in any backyard.

Features

- Convenient wide steps across the width of the pool
- Bench seat across the width of the deep end
- Child safety ledge around the perimeter
- Gradual depth for wading and learning to swim
- Durability, strength and resilience-tested fibreglass pool shell
- Available as a Mineral Water Pool or Salt Water Pool
- Above Ground option available on Federation 9 and below

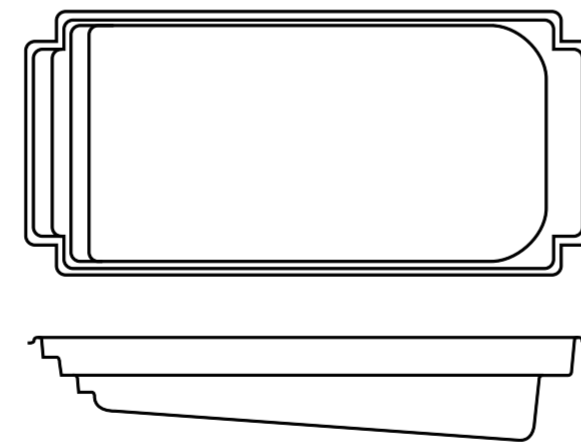

Waterline Dimensions

Name	Length	Width
Federation 8	8.0 m	3.7 m
Federation 9	9.0 m	4.0 m
Federation 11	10.7 m	4.0 m

External Dimensions

Length	Width	Depth
8.3 m	4.1 m	1.10 m - 1.60 m
9.3 m	4.3 m	1.10 m - 1.70 m
11.0 m	4.3 m	1.10 m - 1.80 m

*Lengths, widths and depths may vary up to 3%. External measurements are to widest point on each side of the outside edge. Waterline dimensions are the length and width measured at the top of the coping. Depth is from deepest part of internal shell coping. Unless indicated otherwise, pools are non-diving and use of diving equipment is prohibited.



Bondi Sand



Green Malachite

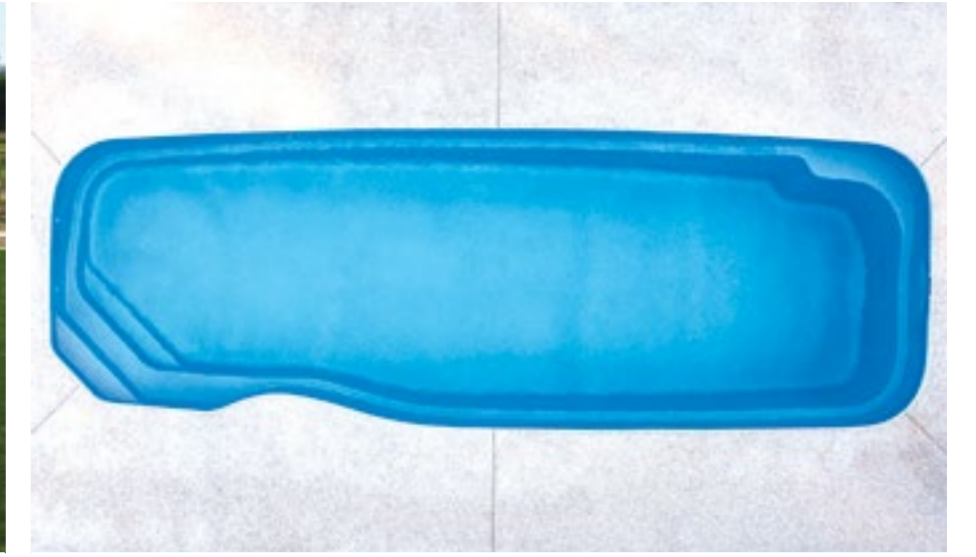

Grey Quartz



Blue Agate



Grey Quartz

ATLANTIS

The Atlantis has been designed with family in mind. With its soft edges and smooth lines, this is the ideal solution for lap swimming and family fun.

Features

- Elegant wide corner entry
- Ledge seating on opposite sides
- Child safety ledge around the perimeter
- Gradual depth for wading and learning to swim
- Durability, strength and resilience-tested fibreglass pool shell
- Available as a Mineral Water Pool or Salt Water Pool
- Above Ground option available on Atlantis 9 and below

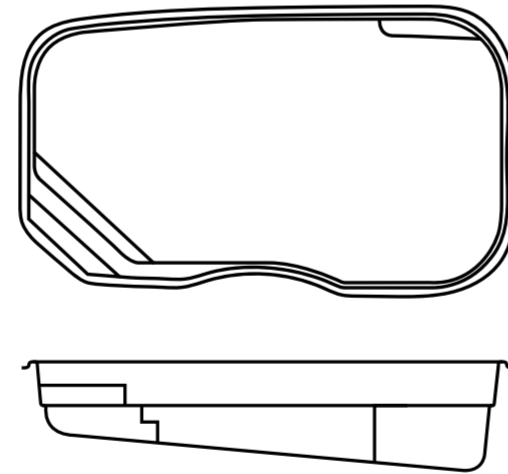

Waterline Dimensions

Name	Length	Width
Atlantis 6	6.0 m	3.6 m
Atlantis 7	7.0 m	4.0 m
Atlantis 8	8.0 m	4.0 m
Atlantis 9	9.0 m	4.0 m
Atlantis 10	10.0 m	4.0 m
Atlantis 12	11.7 m	4.0 m

External Dimensions

Length	Width	Depth
6.3 m	3.8 m	1.05 m - 1.50 m
7.3 m	4.2 m	1.05 m - 1.60 m
8.3 m	4.2 m	1.05 m - 1.70 m
9.3 m	4.2 m	1.05 m - 1.80 m
10.3 m	4.2 m	1.10 m - 1.90 m
12.0 m	4.3 m	1.10 m - 2.10 m

*Lengths, widths and depths may vary up to 3%. External measurements are to widest point on each side of the outside edge. Waterline dimensions are the length and width measured at the top of the coping. Depth is from deepest part of internal shell coping. Unless indicated otherwise, pools are non-diving and use of diving equipment is prohibited.



Rockpool 9, Grey Quartz



Rockpool 9, Green Malachite



Rockpool 9, Blue Agate



Rockpool 7, Blue Azurite



Rockpool 9, Green Jadeite

ROCKPOOL

If you want to create a lush lagoon or a tropical paradise, the Rockpool is the perfect choice. Its natural free-form shape creates a relaxing atmosphere and a personal oasis in any backyard.

Features

- Smooth curved shape
- Large wading area
- Several seating points
- Convenient wide steps
- Child safety ledge around the perimeter
- Durability, strength and resilience-tested fibreglass pool shell
- Available as a Mineral Water Pool or Salt Water Pool

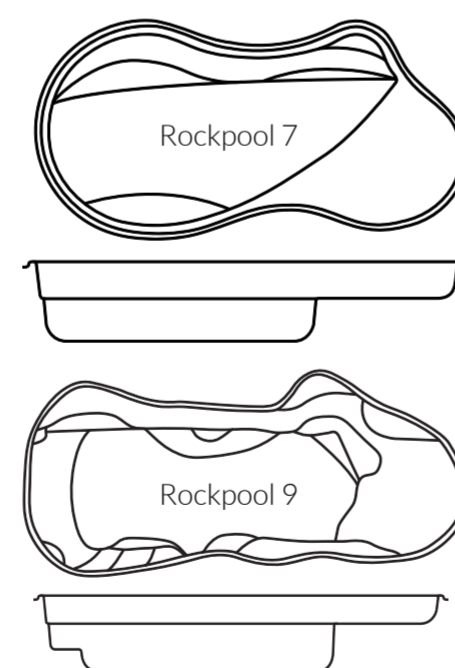

Waterline Dimensions

Name	Length	Width
Rockpool 7	7.1 m	3.7 m
Rockpool 9	9.0 m	3.8 m

External Dimensions

Length	Width	Depth
7.3 m	4.0 m	0.60 m - 1.35 m
9.3 m	4.2 m	0.60 m - 1.70 m

*Lengths, widths and depths may vary up to 3%. External measurements are to widest point on each side of the outside edge. Waterline dimensions are the length and width measured at the top of the coping. Depth is from deepest part of internal shell coping. Unless indicated otherwise, pools are non-diving and use of diving equipment is prohibited.



Bondi Sand



Blue Agate



Princess Spa 6, Blue Agate



Mediterranean Pearl



Blue Azurite

PRINCESS

Bring the resort look and feel into your backyard. The timeless classic features graceful curves that will give you a resort vibe, ideal for any family backyard.

Features

- Smooth curved design
- Convenient steps and seating ledge along the length of the pool
- Child safety ledge around the perimeter
- Gradual depth for wading and learning to swim
- Durability, strength and resilience-tested fibreglass pool shell
- Available as a Mineral Water Pool or Salt Water Pool
- Above Ground options available on Princess 9 and below

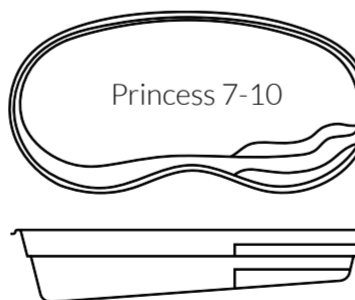
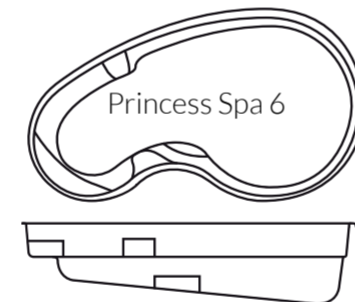

Waterline Dimensions

Name	Length	Width
Princess Spa 6	5.6 m	3.3 m
Princess 7	7.0 m	3.5 m
Princess 8	8.0 m	3.8 m
Princess 9	9.0 m	4.0 m
Princess 10	10.0 m	4.0 m

External Dimensions

Length	Width	Depth
6.0 m	3.4 m	1.00 m - 1.50 m
7.3 m	3.8 m	1.15 m - 1.52 m
8.2 m	4.2 m	1.15 m - 1.66 m
9.2 m	4.2 m	1.15 m - 1.75 m
10.3 m	4.2 m	1.15 m - 1.85 m

*Lengths, widths and depths may vary up to 3%. External measurements are to widest point on each side of the outside edge. Waterline dimensions are the length and width measured at the top of the coping. Depth is from deepest part of internal shell coping. Unless indicated otherwise, pools are non-diving and use of diving equipment is prohibited.



Eden 4.5, Blue Agate



Eden 5.5, Platinum Pearl

EDEN

A modern plunge pool with enough room for the whole family to enjoy, the Eden pool is compact in design, making it perfect for smaller backyard spaces. The Eden features a long bench seat, so you can lounge comfortably with family and friends. Its single depth also makes it ideal for low-impact exercise. Narrow backyard? The Eden Slimline offers all the great features of the Eden in a more narrow design.

Features

- Streamlined design with single depth,
- Long bench seat to sit and relax
- Compact shape perfect for smaller backyards
- Durability, strength and resilience-tested fibreglass pool shell
- Available as a Mineral Water Pool or Salt Water Pool
- Child safety ledge around the perimeter
- Above Ground option available on full Eden Range

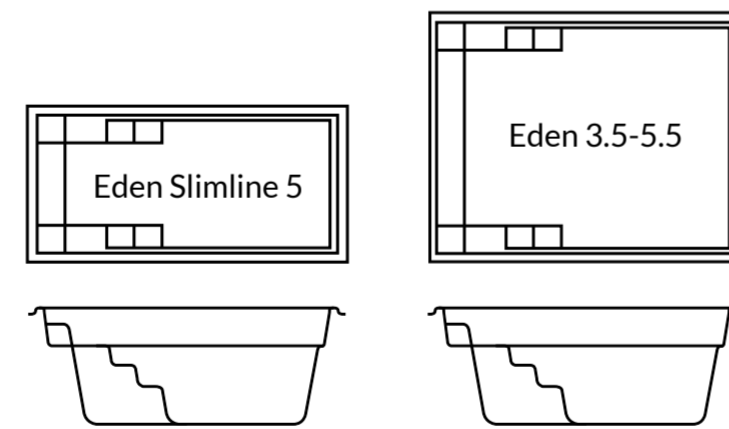

Waterline Dimensions

Name	Length	Width
Eden 3.5	3.2 m	3.2 m
Eden 4.5	4.2 m	3.2 m
Eden 5.5	5.2 m	3.2 m
Eden Slimline 5	4.7 m	1.8 m

External Dimensions

Length	Width	Depth
3.5 m	3.5 m	1.67 m
4.5 m	3.5 m	1.65 m
5.5 m	3.5 m	1.65 m
5.0 m	2.1 m	1.67 m

*Lengths, widths and depths may vary up to 3%. External measurements are to widest point on each side of the outside edge. Waterline dimensions are the length and width measured at the top of the coping. Depth is from deepest part of internal shell coping. Unless indicated otherwise, pools are non-diving and use of diving equipment is prohibited.



Eden Slimline 5, Aquamarine

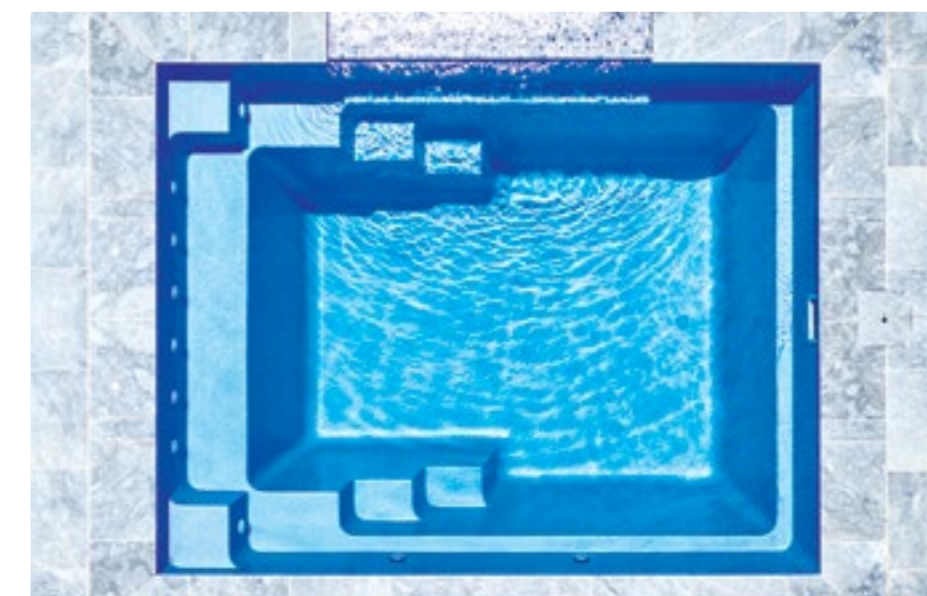

Eden 4.5, Mediterranean Pearl



Eden 3.5, Blue Azurite



Grey Quartz



Grey Quartz

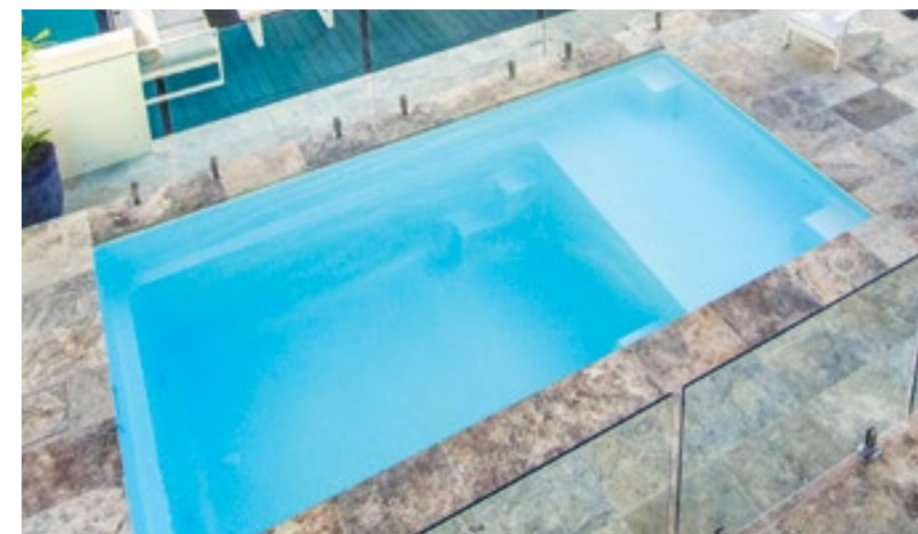

Whitehaven Pearl

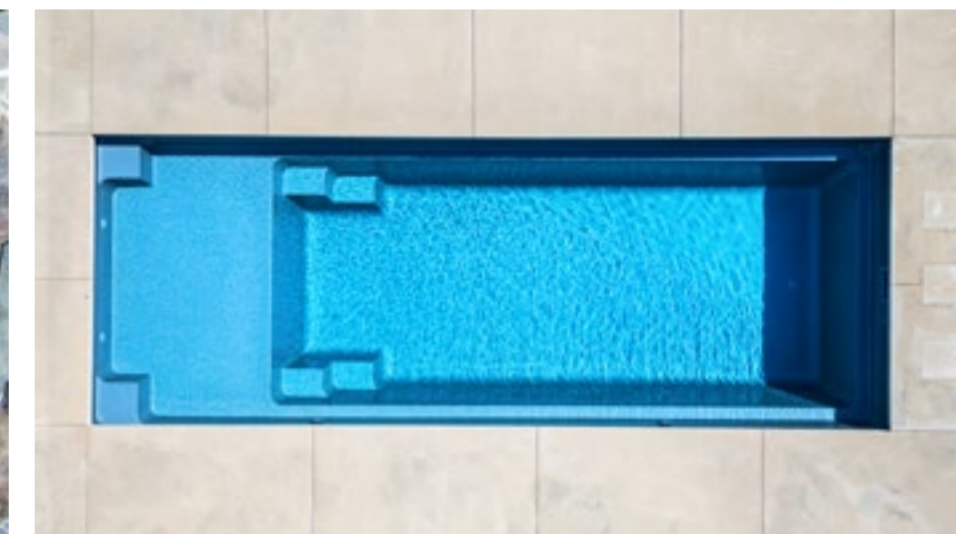

Platinum Pearl



River Rock

NIRVANA

The Nirvana captures the essence of poolside luxury and relaxation. With a resort style splash deck, deep swimming area and contemporary lines, it's been created to bring peace and tranquility by providing a retreat from modern life.

Features

- Splash Deck 1.4m x 2.6m
- Ideal for children gaining water confidence or a place to relax
- Dual steps into swimming area from Splash Deck
- Compact pool shape, perfect for smaller backyards
- Child safety ledge around the perimeter
- Durability, strength and resilience-tested fibreglass pool shell
- Available as a Mineral Water Pool or Salt Water Pool
- Above Ground option available on full Nirvana range

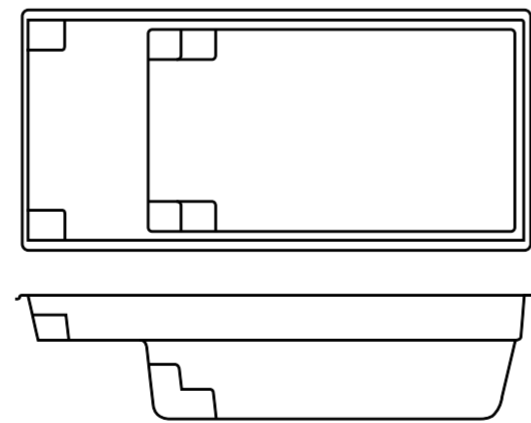

Waterline Dimensions

Name	Length	Width
Nirvana 5	5.0 m	2.7 m
Nirvana 6	6.0 m	2.7 m
Nirvana 7	7.0 m	2.7 m

External Dimensions

Length	Width	Depth
5.3 m	2.9 m	1.45 m
6.3 m	2.9 m	1.45 m
7.3 m	2.9 m	1.45 m

*Lengths, widths and depths may vary up to 3%. External measurements are to widest point on each side of the outside edge. Waterline dimensions are the length and width measured at the top of the coping. Depth is from deepest part of internal shell coping. Unless indicated otherwise, pools are non-diving and use of diving equipment is prohibited.

PLUNGE POOLS

Our Plunge Pools are sure to delight. Designed for use in more compact yards, these designs allow you to cool off in style. Your backyard oasis awaits!

Features

- Generous entry steps
- Child safety ledge around the perimeter
- Durability, strength and resilience-tested fibreglass pool shell
- Available as a Mineral Water Pool or Salt Water Pool
- Above Ground options available on all Plunge Pools

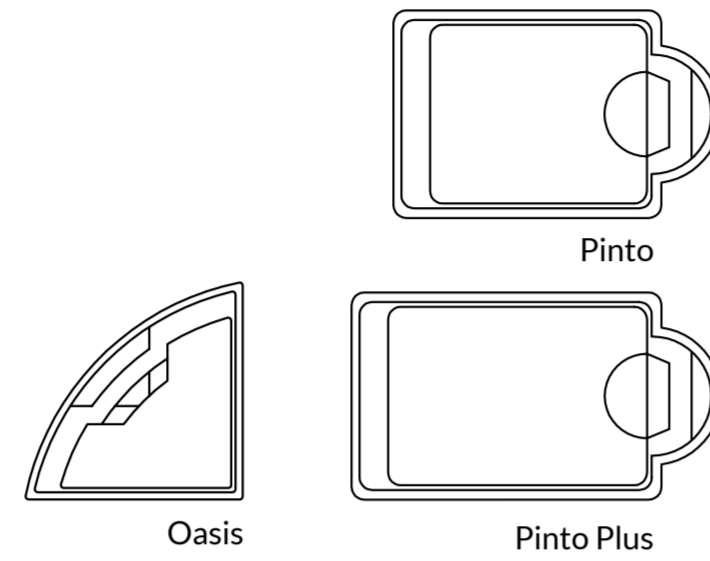

Waterline Dimensions

Name	Length	Width
Oasis Plunge Pool	3.3 m	3.3 m
Pinto Plunge Pool	4.5 m	3.0 m
Pinto Plus Plunge Pool	5.7 m	3.0 m

External Dimensions

Length	Width	Depth
3.6 m	3.6 m	1.65 m
4.7 m	3.2 m	1.60 m
5.9 m	3.3 m	1.60 m

*Lengths, widths and depths may vary up to 3%. External measurements are to widest point on each side of the outside edge. Waterline dimensions are the length and width measured at the top of the coping. Depth is from deepest part of internal shell coping. Unless indicated otherwise, pools are non-diving and use of diving equipment is prohibited.



Oasis, Summer Stone



Pinto, Blue Azurite



Pinto Plus, Blue Azurite



Oasis, Summer Stone

SPAS AND SPLASH DECK

You can create the combination of your dreams with our range of beautiful spas and Harmony Splash Deck. Designed to complement our range of swimming pools, our spas and splash deck offer a perfect blend of style and functionality.

Our spas offer contemporary, clean lines that will complement your property perfectly and blend with a wide variety of surroundings. If a luxurious, relaxing experience is what you're after, a spa from Narellan Pools will tick all the boxes.

Our Harmony Splash Deck has been especially built for children, and perfectly complements our inground swimming pools. With a shallow depth, it's a great space for little ones learning to swim, and just as ideal for an afternoon of lounging with friends.

Features

- Non-slip surfaces
- Shallow, single pool depth perfect for lounging
- Durability, strength and resilience-tested fibreglass shell
- Available as a Mineral Water Pool or Salt Water Pool

Waterline Dimensions

Name	Length	Width
Neptune Spa	2.4 m	2.2 m
Party Spa	2.0 m	1.6 m
Harmony Splash Deck	3.2 m	1.7 m

External Dimensions

Length	Width	Depth
2.6 m	2.4 m	0.90 m
2.5 m	1.8 m	0.91 m
3.5 m	2.0 m	0.40 m

*Lengths, widths and depths may vary up to 3%. External measurements are to widest point on each side of the outside edge. Waterline dimensions are the length and width measured at the top of the coping. Depth is from deepest part of internal shell coping. Unless indicated otherwise, pools are non-diving and use of diving equipment is prohibited.

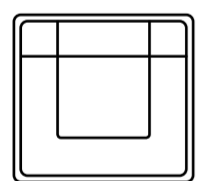

Neptune Spa

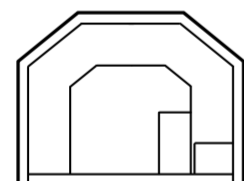

Party Spa

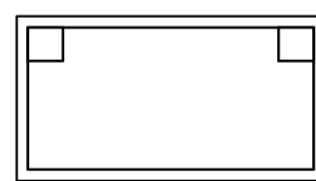

Harmony Splash Deck

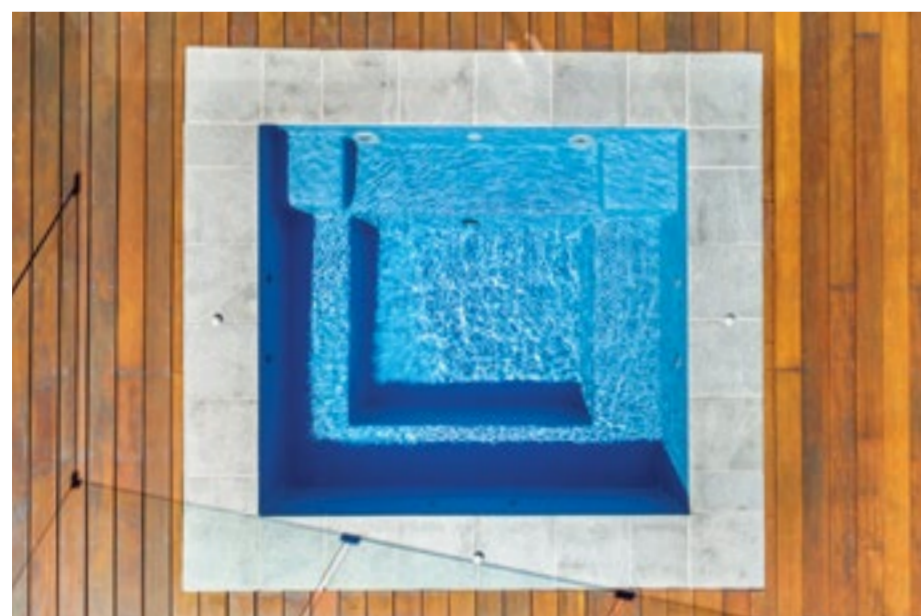

Neptune Spa, Blue Agate



Harmony Splash Deck, Blue Agate



NARELLAN POOLS INGROUND POOL COVER

Now that you've chosen your pool design it's time to consider a pool cover, and installing a pool cover at the same time as your pool is the best time to do it.

A pool cover is more than just a device to stop leaves coming into your pool. A pool cover effectively stops evaporation and keeps your pool warmer so you can swim longer as the months get colder. And if you are installing a pool heater, a pool cover is the most economical way to retain the heat.

A genuine Narellan Pools Inground Pool Cover is the perfect choice for your Narellan Pool. Its' sleek beautiful design neatly keeps your pool cover tucked underground and out of the way, so you can enjoy a clutter free pool area.

Why?

- Aesthetically pleasing design that compliments any pool
- Prevents evaporation
- Saves hundreds of litres of water
- Less cleaning, by protecting against unwanted leaves and dirt
- Less water and less cleaning, means less chemicals
- Slows down temperature loss so you can swim longer
- Reduces heating costs
- Easy to use inground box that doesn't clutter your pool area

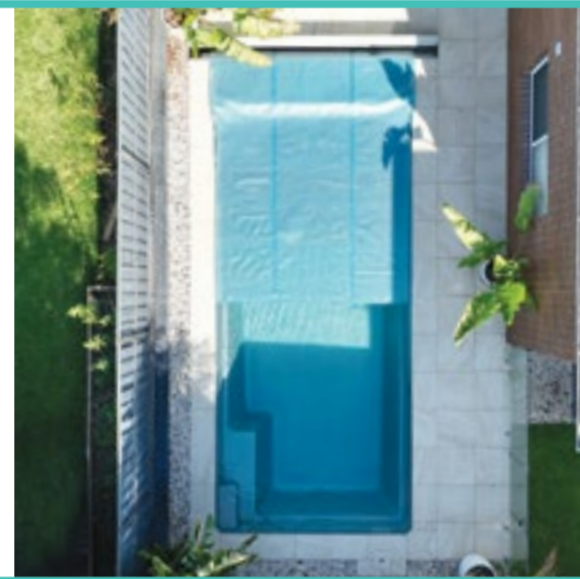

Specifications

- 100% Australian Made
- Fitted flush to your paving, deck or concrete
- Hard-wearing slimline aluminum lid
- Genuine 3:1 mechanical gearbox
- Single person operation



Narellan Pools Inground Pool Cover, Symphony 9, Blue Azurite

CUSTOMISE YOUR POOL

○ Automation

Sit back, relax and let fully automated systems control your swimming pool temperature and even your water chemistry without you having to lift a finger.

○ Swim Jets

Creating a current to swim against for therapy, fitness and aerobic exercise, Swim Jets allow swimmers the physical training they desire.

○ Heating

With a range of quality heating systems available for your pool, you can get the benefits of stable water temperature and an extended swim season. The three types of heating systems are solar, electric and gas. These can be used separately or in conjunction with each other.

○ Cleaners

A clean pool is an inviting pool, and we offer a range of pool cleaners to keep your pool sparkling all year round. We offer robotic and suction cleaners. We will assist you to find an option which will suit your lifestyle and budget.

○ Spa Jets

Relax and unwind - let your pool give you a massage with our in-pool spa inclusions. Choose from either Venturi spa jets or an air manifold system. For maximum effect ask us about having both installed.



Swim Jets

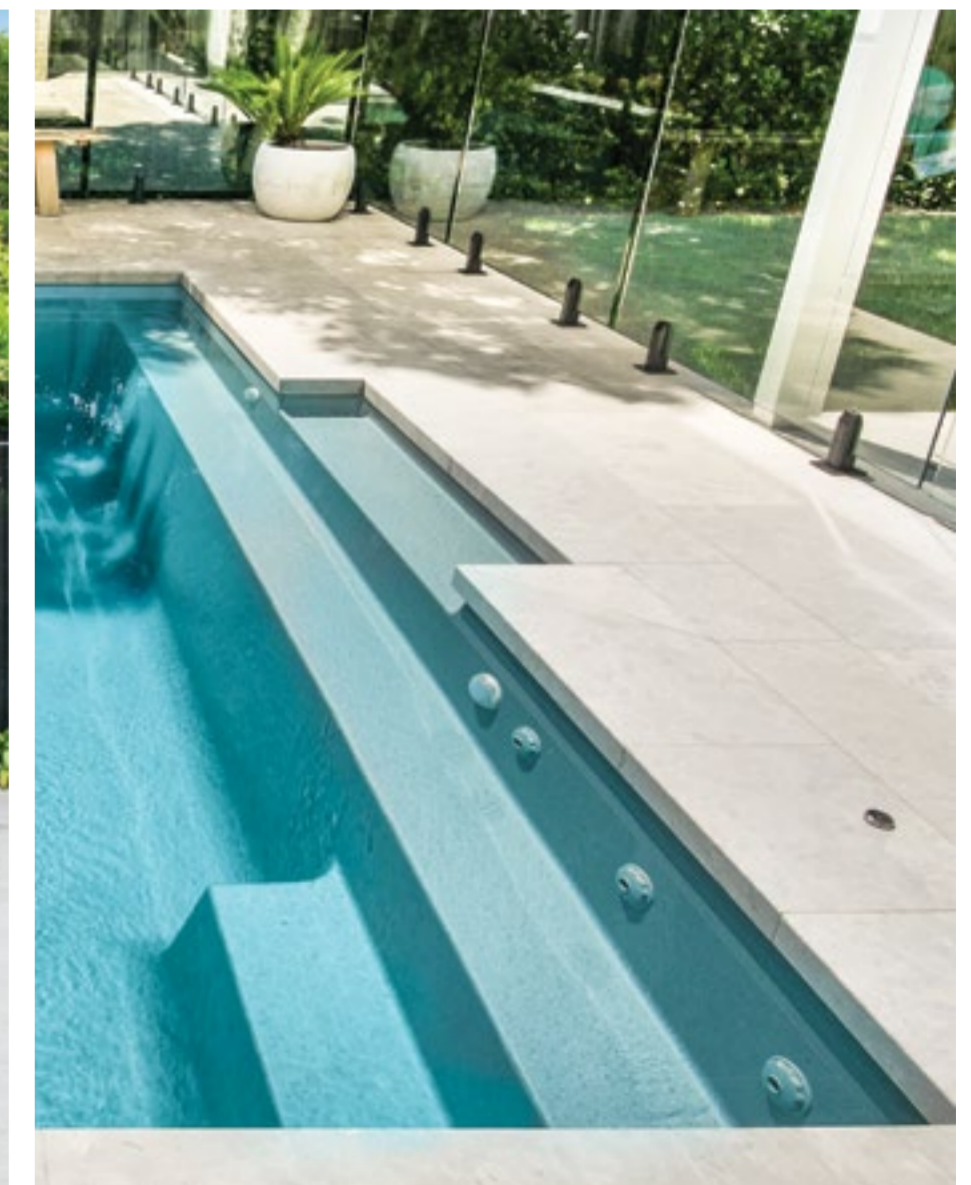

Spa Jets

ABOVE GROUND POOLS

You can now build the pool of your dreams in backyards that previously would have been deemed cost prohibitive or impractical. Our specially engineered pools allow you the flexibility to work with our expert Pool Builders to design a backyard that suits both your budget and lifestyle.

When it comes to installation, our Above Ground option is designed to save you time. These self-supporting pools can help you avoid the need to build large retaining walls, so a sloped yard doesn't mean you have to give up on your dream.

Don't compromise your outdoor designer pool with an unsightly alternative. With a Above Ground Pool, you can enjoy a seamless design which will provide you with a wonderful poolside lifestyle.



1. Grandeur 11, Whitehaven Pearl 2, 3. Installation 4. Eden 5.5, Blue Azurite
5. Nirvana 6. River Rock 6. Eden 4.5, Grey Quartz 7. Grandeur 9, Mediterranean Pearl





Grandeur 9, Neptune Spa, Grey Quartz

OUR WARRANTY, YOUR PEACE OF MIND

Narellan Pools manufactures fibreglass pools to the highest standards, and we're committed to ensuring your experience owning one of our pools is hassle-free.

We aim to ensure your investment is future-proof. Each inground fibreglass pool we sell comes with a manufacturer's lifetime structural warranty*, so you can have total peace of mind.



Pool Owner's Manual

We provide our clients with a Pool Owner's Manual, which is a comprehensive document that guides you how to keep your pool in peak condition. By following our guidelines, you'll make sure your warranty is valid, and your pool stays clean, healthy and ready to use.

Client Care

Narellan Pools has built its reputation as a leader in our industry by focusing on quality and integrity. Not only will we look after you during pool installation – we'll also be ready to help if a problem arises. We have a dedicated Client Care Team available to help, so you'll feel confident you have all the information you need.

You can contact our Client Care on **1800 045 015**.

***Disclaimer:** For more information in relation to the Narellan Pools warranty (including warranties on the surface or above ground pools, warranty coverage, applicable warranty periods, conditions for making a claim and warranty exclusions) talk to your local pool builder.

QUALITY ASSURED AT EVERY STAGE

Our standards for safety and quality set the benchmark. These standards apply to all areas of our operation, from manufacturing, to installation, and to ongoing client care and support.

Our unwavering commitment to quality is entrenched in every part of our business; stringent quality control and checks at each stage of the swimming pool manufacturing process guarantee each one of our fibreglass pools are manufactured to the optimum strength and durability.

- **Advanced manufacturing processes**
- **Team training**
- **Passionate Pool Builders**
- **Quality checks**
- **ISO 9001 accredited manufacturing facilities**
- **Commitment to research and development**
- **Microchip technology**
- **Quality transportation and handling procedures**

At every step we have the right process in place to deliver the ultimate client experience and ensure you have peace of mind for decades.

WE'RE IN THIS TOGETHER WHICH MEANS OUR WORK BEHIND THE SCENES ENSURES YOU CAN FOCUS ON SWIMMING

○ Quality Management System

Combining 50 years of manufacturing experience and independent annual auditing.

○ Microchip

A microchip is embedded into every pool, which is the key to unlocking the specific fibreglass data. Test results and a retained fibreglass sample are recorded and kept for every pool.

○ Installation

Installation is provided by highly qualified, fully licenced, locally owned and operated Pool Builders. We're proud to have the best trained Pool Builders in the industry.

○ Pool Manufacturing Certificate

Tracks the pool from conception to completion and records: time of day, room temperatures, technicians, material batch numbers and pool weight, just to mention a few.

○ Closed Loop Accountability

Every client is contacted to ensure complete satisfaction. We measure ourselves and our Teams against our clients' feedback with our Net Promoter Score.

○ Dispatch and Distribution

A dedicated Logistics Coordinator is assigned and has 100% control over your pool's pre-dispatch reports, logistics planning and safe arrival.

OUR MANUFACTURING

50 years of innovation, engineering and composite development has resulted in the creation of the world's best fibreglass pool shell. Our proprietary gelcoat and laminate construction ensures our pools withstand all climate conditions and soil types in any location worldwide.

Technically Brilliant

- ISO 9001 accredited manufacturing facilities
- Stringent selection of raw materials
- World-class state of the art manufacturing facilities
- Manufactured to exceed Australian standards
- Highly qualified expert technicians
- Monitored thickness testing throughout the process
- Detailed quality controls and checks at each stage of the process
- Unique identification for each pool through microchip technology
- A formal process for continuous improvement of products and processes

Our unique fibreglass formula provides you with:

- Quality in every layer with maximum interlaminar adhesion
- Optimal thickness consistently throughout the pool
- Maximum durability through added reinforcements in the manufacturing process
- Balanced flexural and tensile strength

Tested and trusted



Total quality management



Ultrasonic thickness testing



Detailed inspection



Accelerated boil test



ISO 9001



Raw materials



pH and chlorine test



UV test



Australian craftsmanship



**HANDCRAFTED
WITH CARE
FOR YOUR FAMILY**





ENVIRONMENTALLY CONSCIOUS TODAY FOR A BETTER TOMORROW

Narellan Pools is absolutely committed to reducing our carbon footprint. It's important we all take steps to reduce environmental impact. Our focus on environmentally conscious practices and materials extends to all areas of our operations.

We also want to make it easier for you to choose pool accessories and equipment that are kind to the environment.

Our local Pool Builders can provide you with eco-friendly options for your pool to lessen your carbon footprint and impact on the environment.

More Eco Sanitation of Your Pool

We have a range of sanitation solutions including mineral, that are more eco-friendly for your swimming pool, further improving the water quality and not harming the environment like traditional chlorination systems.

Water-Wise Pool Builders

We understand the importance of managing water wisely without sacrificing the family fun of owning a swimming pool. Our local Pool Builders can help you discover ways to conserve water and help the environment.

Reduced Electrical Consumption

We can provide you with highly energy efficient equipment. There are filtration systems available with variable speeds, so they use less energy and make less noise.



INTRODUCING NARELLAN POOLS AUGMENTED REALITY (AR) APP

The first step in the journey that will **change your family life**

The Narellan Pools Augmented Reality (AR) App uses cutting edge technology to digitally place any Narellan Pools swimming pool to scale, in your backyard. Augmented Reality allows you to interact with a virtual world. With this technology, Narellan Pools AR brings the pool showroom into your backyard!

Narellan Pools AR allows you to play around with your design ideas, so you can see what aligns with your vision and what works best with your backyard. Deciding between a Symphony or Grandeur? Bring up Narellan Pools AR to see both pools in full scale in your yard. Selecting the right pool colour is also made easy with Narellan Pools AR. Whether you're leaning towards Whitehaven Pearl or you're contemplating Blue Agate, Narellan Pools AR will help you get a clear picture of the pool colours you love.

Download the **Narellan Pools AR App**



Use Narellan Pools AR to:

- View any Narellan Pools swimming pool in 3D, miniature or full-scale - the choice is yours!
- Get a clear visual idea of how one of our pools will look in your backyard.
- Instantly access dimensions of your favourite Narellan Pools designs - the details are all in one place.
- Share digital visuals of your dream pool with your family and friends via text, email or Facebook.
- Show your local Narellan Pools Builder the pool designs and colours you're considering.
- Get even more excited about starting the journey to your pool!



Panama 8, Aquamarine

LOCAL POOL BUILDER

Manufactured by Narellan Pools, Installed by Narellan Pools

We've built our reputation as a leader in fibreglass swimming pool installation through our client focused culture, ensuring their experience with us is personalised, transparent and hassle-free. Our local Pool Builders live and breathe this dedication to client service. They are backed and supported by world class training and systems Narellan Pools has developed.

Your local Pool Builder is qualified and expertly trained. They are equipped with specialised Narellan Pools training. This means you can rely on them to understand your vision, and make your dream pool a reality. They will guide you through the journey to achieving your dream pool. Your local Pool Builder will engage with you to devise a tailored solution to fit with your space and align with your personal style.

Narellan Pools operates with integrity across the board, with a shared commitment to excellence. From manufacturing your pool shell in our state-of-the-art facilities, to installing the pool of your dreams at home, we aim to deliver a seamless client experience.

Your local Pool Builder will oversee the journey of your pool from the beginning, and will keep you informed throughout. It's our knowledge, people and passion that really set Narellan Pools apart.



Narellan Pools Macarthur

LOCAL BUSINESS, NATIONAL SUPPORT, INTERNATIONAL PRESENCE

We're in this together

Our local Pool Builders have access to our industry-leading tools and systems, and they are backed by a global operations team with an unwavering commitment to client service. We don't just operate transparently with our clients – Narellan Pools prides itself on transparency across its operations. We share knowledge, and research and development updates across our teams, which has contributed to our incredible international growth.

When you interact with your local Pool Builder, you'll have the support of a highly reputable, client-centric brand that has the support of local builders with an international presence.

All this means, we've got you covered.



Narellan Pools Conference 2023 - Queenstown New Zealand

INSTALLATION

Bringing your dream to life with Narellan Pools will be hassle-free.

With your local qualified Narellan Pools Builder, your dream pool is in the best hands as we will take care of everything for you.

With our five step construction process, building your dream pool is often faster than you think. Your local Pool Builder will guide you through each stage, from conception to completion.



Conception and Consult

During your design consult, we will create your site plans, and discuss and design what you wish to achieve with your swimming pool and its surrounds.

We can also map out optional needs like landscaping and paving, and begin the process of securing necessary statutory approvals.

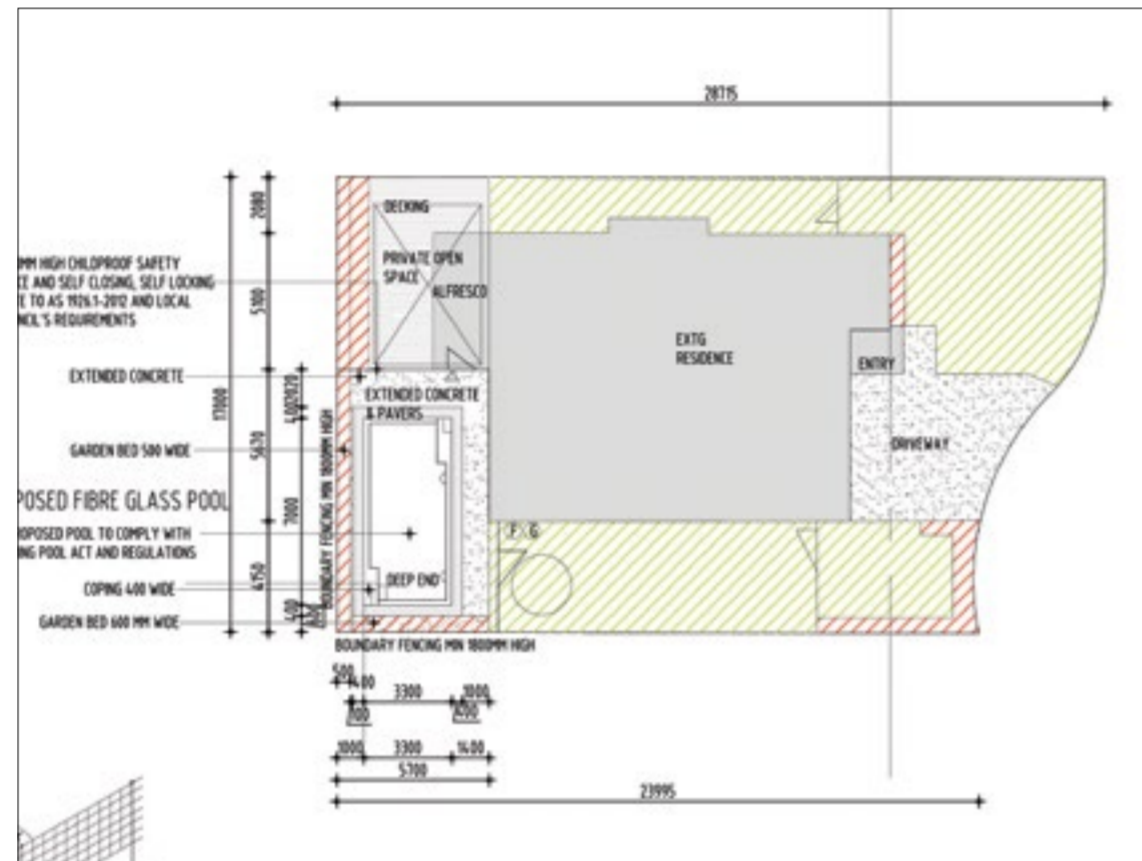

Excavation

After your plans have been approved, your local Narellan Pools Builder will prepare the site for excavation, and begin the process so that your pool shell can be placed into position.



Construction

Your pool will be delivered to your site and carefully placed into position. All plumbing and filtration equipment will be installed at this time as well.



Structural Beam

The final structural component of your pool is the pouring of the structural bond beam on top of the pool edges. The beam is designed to act like a seal, and with the support of backfilling and drainage, your in-ground pool will be locked securely into the ground.



Handover

After completion of the construction steps, your local Narellan Pools Builder will carry out a 'handover' process. You will be instructed on how to use your pool equipment, and receive your Pool Owner's Manual. This manual will equip you with the information you need to care for your pool in line with its warranty requirements.



OUR PHILANTHROPY

At the core of Narellan Pools is a philosophy of making a difference and giving back to the communities we operate in.

Narellan Pools believe if everyone shared the philosophy of giving back, the world would be a better place. Inspired by their leadership and belief, the Narellan Pools community is passionate about improving lives and creating change where it's needed.

Narellan Pools' commitment to remaining ethical whilst contributing to economic development and improving the quality of life of communities we operate in, is an absolute focus and passion.

THE SPLASH FOUNDATION BY NARELLAN POOLS

Community is one of the Narellan Pools' values and we love to support the communities in which we operate. After years of actively supporting a range of not-for-profit organisations, Narellan Pools has taken a significant step forward by launching our very own foundation.

The SPLASH Foundation is a Narellan Pools initiative that offers Australian community groups the unique opportunity to obtain their very own Narellan Pools fibreglass swimming pool, when they otherwise might not be able to afford one.

So, whether you represent a community organisation, a school, a local sporting group, a club, a rehabilitation centre or even a retirement facility, Narellan Pools is giving you the chance to have a positive impact on your community, with a brand new Narellan Pool!



For more information



Grandeur 9, Whitehaven Pearl







Cover Image

2023 Pool of the Year Winner - **Central West / Blue Mountains**
Grandeur 11, Neptune, Black Onyx



Narellanpools^o

Narellan Pools Style Guide **AUSTRALIA** - Published 2024
Copyright © 2024 Narellan Innovations Pty Limited. All rights reserved.

Style Guide



A3 Brochure